

European Research Centre for  
Book and Paper  
Conservation-Restoration

# Conservation Update

Publication of the ERC

November 2019

***Editorial board:***

Dmitrieva, Maria  
Kostadinovska, Maja (layout)  
Reid, Zoë

***Webpage:***

Wenger, Emanuel

***Facebook and Twitter account:***

Ruiz Segura, Pascual

***Picture on the cover and watermark of pages throughout the publication:***

Image from page 11 of “A history of paper: Its genesis and its revelations” (1882)  
(free for commercial purposes and re-publication).

***Copyright:***

European Research Centre for Book and Paper Conservation-Restoration  
ISSN: 2663-0125

## Contents

Foreword.....	3
<b>1. RECENT ACTIVITIES OF ERC.....</b>	<b>5</b>
Ink Corrosion Conference and Workshop, Krems 24-27 <sup>th</sup> October 2019.....	5
AFFANDI - Contemporary Heritage of Indonesia and its preservation held at Danube University Krems, Austria, Thursday, 17 October 2019.....	5
Ligatus Summer School 2019.....	7
XIV IADA Congress Warsaw 23-27 September 2019.....	8
We have new national representatives.....	8
ERASMUS+ .....	9
Update on the Facebook Page – A Short Note.....	10
The new link – the ERC Library .....	11
Evaluation of restoration and conservation methods for cultural heritage and creation of a decision matrix for archives, librarians and restorers.....	11
Impact of old conservation methods on leather and parchment .....	12
Research .....	13
Archive and Museum - Conservation concept for paintings on canvas and paper, notebooks, drawings, glass plates, photographs, plans and films of the Museum Affandi and the archives of the temple of Borobudur UNESCO Cultural Heritage site listed as an UNESCO Memory of the World in 2017 as a joint training with building up the department of conservation-restoration in ISI, Yogyakarta (2019) .....	13
WAYANG BEBER, a unique cultural heritage of Indonesia – conservation concept (2019) .....	13
<b>2. ARTICLES.....</b>	<b>14</b>
The “Libri censuales” – Freising manuscripts from conservation to digital edition.....	14
Filling in Missing Parts of Documents by the Method of Air Dynamic Forming .....	25
<b>3. UPCOMING EVENTS.....</b>	<b>32</b>
<b>Our events.....</b>	<b>32</b>
Call for Papers and Posters	
Book Conservation: One Philosophy – Many Interpretations .....	32
<b>Other’s events.....</b>	<b>33</b>
<b>2020</b>	
2 <sup>nd</sup> Annual Conference Craft and Book 2020 .....	33
Care and Conservation of Manuscripts 18 .....	33
PAPER STORIES: Paper and Book History in Post-Medieval Europe.....	33
DSL2020 MALTA, 16th International Conference on diffusion in solids and liquids.....	34
ICOM-CC 19th Triennial Conference Theme: Transcending Boundaries: Integrated Approaches to Conservation.....	34
<b>4. CALL FOR PAPERS FOR THE APRIL ISSUE 2020.....</b>	<b>34</b>
<b>IMPRESSUM.....</b>	<b>35</b>
<i>Sponsors</i>	

# Foreword

Dear readers,

Welcome to the second edition in 2019 of Conservation Update from ERC. We have had an extremely busy and productive few months. I am delighted to report that the **Ink Corrosion Conference**, during October which aimed to identify our professional understanding of the decay process caused by iron gall inks, the conservation methods applied and identified what areas of research should be addressed next was a huge success. Not only were there speakers from all over Europe, USA, Canada, Mexico and Asia who presented high quality contributions, but the exchange with participants made the conference an interesting event. The friendly atmosphere over the 2 days, once again proved the spirit of our Centre. The **Ink Course** followed the conference and provided the opportunity for some to combine their attendance of both ink-related events. There is a review of that week on page 5.

Talking about recent events, I should point out our evening on the 17 October with Kartika Affandi and the Ambassador of Indonesia in Austria, his excellency Dr. Darmansjah Djumala. See a full review on page 5.

It was also a great honour for the ERC to host the **Ligatus Summer School** in Krems this year. It provided us with the opportunity to strengthen our cooperation with Ligatus Research Centre <https://www.ligatus.org.uk/> as well as with local abbeys and their libraries, Melk, Kremsmünster, St. Florian and Zwettl and the archive of the city of Krems. A review of the course is on page 7.

After the success of the Ligatus summer school we hope to resume offering one-week courses as we presented between 2011 - 2013. These were presented by such experts as Jiri Vnoucek, Jan Vouters, Gangolf Ulbricht and were highly appreciated by the international community. We are already planning courses for next November; check our webpage regularly **Events and courses** for news and updates <http://www.restauratorenohnegrenzen.eu/erc/Courses/>. We welcome requests for future courses, all suggestions should be sent to your national representative (please see the representatives' names on our webpage <http://www.restauratorenohnegrenzen.eu/erc/Board/>).

The national **Representatives** are working for you – they communicate wishes from you to us and information from us to you. So please give them your addresses and contact information, in case you are still not on your representatives' list.

I would like to thank Petra Vavriva (Czech Republic) and Julia Bispink (Germany) for their many years of work as national representatives to the ERC.

This is also the moment to **welcome our new representatives** from **Egypt** Sherif Afifi; **India** Namita Jaspal; **Estonia** Ruth Tiidor; **Germany** Anne Nadolny **Lithuania** Birute Giedritiene and **Serbia** Željko Mladićević. I would also encourage our Erasmus students to send information to their individual representative to foster a lively exchange, which will also gradually involve universities.

Some of the representatives took over a larger workload, such as Zoë Reid (Ireland) and Maria Dmitrieva (Russia) who are the editors of our peer-reviewed periodical "Conservation Update". Maja Kostadinovska (North Macedonia) looks after the layout of the periodical. I would like to extend my thanks to them for undertaking this work and giving their time to make the journal come to life twice a year. <http://www.restauratorenohnegrenzen.eu/erc/Publications/>

As requirements for continued professional development and project application become more and more demanding, publications in peer-reviewed periodicals are more valuable than ever, so please consider submitting an article. Full details can be found on page 34.

Penny Banou (Greece) has brought together information about conferences, generating a valuable calendar of upcoming events. <http://www.restauratorenohnegrenzen.eu/erc/OtherEvents/>

*This way, our website will soon be not only a place to get information on events in Europe and beyond but also to enable organizers of new conferences to avoid any potential overlaps in time. If you have any information that you would like included please contact Penny.*

*Pascual Ruiz Segura (United Kingdom) manages the ERC Facebook page and he welcomes your pictures and information on all sorts of relevant conservation activities in your country, especially if they have a direct connection with ERC.*

*Some of the national representatives drafted and submitted applications for EU funded research projects on our behalf, for this we thank them for their work. Again this is an example of the ERC community and utilizing it as a pool of project partners for funded projects, which is surely one of our key objectives.*

*Our aim is to create tools for us all that would suit our needs and to become a centre for all of us – a community where anyone whose ambition it is to help preserve the world's written and graphic heritage feels at home and sees their expectations met. In case you miss some tool, please do tell us, and in case you miss some solution for a conservation problem, please tell us, too.*

*I am delighted and excited to announce that 2020 will be a very special year for the ERC, as we celebrate the 10<sup>th</sup> Anniversary of the foundation of the Centre. The Centre was officially founded on 22<sup>nd</sup> March 2010.*

*The first years of our existence saw implementation of the idea behind the Centre by concerted effort and perfecting the scheme by bringing it under a university's auspices and consolidating its position. Now we have a good standing at a university with a good international reputation. This is mostly the fruits of the work of our experienced Board members and we thank them for their continued support.*

*We will hold a conference to commemorate the event and we hope to have all Board members and all national representatives as well as many more colleagues and friends in the beginning of November 2020 with us.*

*We will do everything to make it an unforgettable event.*

*So, it only leaves me to invite you warmly to use the tools and possibilities our team provides to you for free:*

- *the webpage and its tools,*
- *the peer reviewed CU*
- *and the communication of your requests via your national representative.*

*I look forward to meeting as many of our readers, board members, national representatives, alumni from ERC courses and former Erasmus students during 2020.*

*Patricia Engel*

*Head*

*European Research Centre for Book and Paper Conservation-Restoration,  
Zentrum für Kulturgüterschutz,  
Department Bauen und Umwelt,  
University for Continuing Education Krems,  
Dr. Karl Dorrekstr. 30, 3500 Krems,  
Austria.*

## 1. RECENT ACTIVITIES OF ERC

### **Ink Corrosion Conference and Workshop, Krems 24-27<sup>th</sup> October 2019**

*Sarah Graham, Head of Conservation, Public Record  
Office of Northern Ireland (PRONI)*



At the end of October, conservators, conservation scientists and chemists from all over Europe, America, Canada and Qatar went to the beautiful city of Krems to discuss corrosive inks. Iron gall ink is ubiquitous in collections and provide complex problems for treatment. As such, it was identified as one of three key areas of collaboration by the European Research Centre in 2011 at their first international conference. I attended both the conference and the workshop as they complimented each other well and mixed research with practical understanding of the ink's production.

The conference papers discussed; research being carried out on varying treatments, analysis of how the corrosive components are responding to different environments and identification materials or processes. The quality of all the presentations was very high but of particular interest to me were those which discussed practical treatments or problems faced at the bench.

Maria Carma Sistach showed her way of treating inks without disbinding Spanish manuscripts by simultaneously de-acidifying and applying a layer of tissue to consolidate the substrate. This talk interestingly also highlighted the importance of acidity rather than humidity in corrosion. If treating corrosive inks was not complex enough, Julie Biggs was testing phytate treatments water-sensitive iron gall inks and kindly shared her comprehensive and colourful results.

There were also some good questions posed. Penelope Banau brought some fascinating examples of letterpress copy books and discussed whether the condition of the

iron gall inks was a result of the production of a copy or a consequence of deterioration. In the conference round-up, there were suggestions of a literature review of existing research and standardising research in studios would allow the result to be compared more easily. Both would be great tools for deciding the best treatment in the studio. After the conference, the ink workshop was an opportunity to look at recipes from across Europe, discuss why they vary and the properties each ingredient was bringing to the finished ink (Fig.1). I learn through my fingers and this was a practical way of understanding why the inks behave as they do. We also discussed substituting ingredients as a number are now hard to find, soot from linseed oil for example. This would have been easy enough to find in lamps, but much harder to gather now. We had a good attempt (Fig.2) but were not able to gather the quantities needed. Instead, we used Patricia's homemade charcoal from grape seeds. After the inks were made we used different writing implements and supports to see how the inks were responding. It encouraged me to look at recipes which would be more local to Ireland and age them back at the studio.



The course and the conference went together well. Conservation is so interdisciplinary and these four days reflected many of these different areas, from the technically scientific to practical experimentation. In the conference, some of the more chemistry-based presentations tested the parameters of my understanding and improved my knowledge of the molecular intricacies as a result. It is only from the collaboration between conservators, conservation scientists and chemists that we will find thoroughly researched practical, techniques to use on large collections and this conference provided a great forum.

### ***AFFANDI - Contemporary Heritage of Indonesia and its preservation held at Danube University Krems, Austria, Thursday, 17 October 2019.***

This meeting presented Kartika Affandi, the daughter of one of the pioneers of famous painters from Indonesia - Affandi Koesoema, as the Chairperson of the Affandi Foundation and the successor painter to her father. This activity was the result of a series of collaborative activities with Austria in the conservation or preservation of Affandi's paintings since 1980, and conservation of the unique architecture of the Affandi Museum.

In addition, the transfer of technology to the influence of climate science on art objects by a consortium of universities - Danube University Krems, Technical University Vienna, Gadjah Mada University Yogyakarta, and Yogyakarta Indonesian Art Institute. On the occasion, the Indonesian Ambassador to Austria, Slovenia and the Permanent Representative of the Republic of Indonesia to the United Nations and other International Organizations in Vienna, Dr. Darmansjah Djumala, had the opportunity to deliver a keynote speech in the opening session.

Indonesian Ambassador Djumala expressed his appreciation to ASEA-UNINET, Austrian-Indonesia Society, Danube University-Krems and Technology University-Vienna in initiating events like this. He said efforts like this showed that people to people contact contributed to bilateral relations between Indonesia and Austria.

*"High appreciation should be conveyed for the Affandi Museum's conservation efforts by several consortia of universities in Indonesia and universities in Austria within the framework of ASEA UNINET, initiatives for the transfer of technology in the conservation of paintings and Affandi Museum, and the efforts of Ms. Kartika Affandi as one of the leading painters in Indonesia, who is also Affandi's son in developing painting and the Affandi Museum Foundation" said Ambassador Djumala.*



In a dialogue led by Danube University Krems researchers, Kartika Affandi underlined the desire to continue Affandi's teachings as an art teacher and her father to form the Affandi Museum Foundation. The foundation is a forum for the teaching of painting and architectural art of Indonesia's young generation including those with special needs.

*"I actually learned dance when I was sent to study in exchange for a scholarship for Affandi to India. Affandi was rated as a self-taught painter and architect and teacher, so there was no need for this scholarship. In the end I believe that someone was born to be a painter and Affandi is my teacher" he said.*

### **ASEA-UNINET Initiative**

The talkshow "**AFFANDI - The Contemporary Heritage of Indonesia and its preservation**" was mainly focused on Affandi's artwork (paintings and museum architecture) and the efforts undertaken by Kartika Affandi to restore and maintain the works. This activity was carried out thanks to the initiative and cooperation between ASEA-UNINET, an organization engaged in the university network consisting of European and Southeast Asian universities aimed at promoting, internationalizing education and sustainable research.

ASEA-UNINET is a framework of cooperation for the development of cooperation between 5 universities in Indonesia with 4 universities in Europe. The activity was also supported by the Austrian-Indonesian Society, which is an Indonesian-Austrian community organization under the auspices of the Indonesian Embassy / Vienna Republic of Indonesia. This institution consists of Austrian professional figures and professional Indonesian citizens in Austria, who love Indonesia and want to contribute to the improvement of Indonesia-Austria relations through various socio-cultural activities, and education by the people of the two countries.

Dean of the Faculty of Education, Arts and Architects, Danube University Krems, academics from various universities in Austria, Indonesian students in Austria and other prominent figures were present at the event. For information, efforts that have been made by a consortium of universities in Indonesia and Austria for the conservation of the Affandi Museum first began in 2016. Through a network under the aegis of the ASEA-UNINET, the universities have begun various series of collaborations in various interdisciplinary projects on methods and concepts for the preservation of paintings and various other architectures.

It is hoped that the heritage of the painter maestro Affandi can continue to be preserved as a teacher of the young generation of Indonesian painters.

Learn more about **ASEA-UNINET** projects in this periodical below (See **Research section**).

<https://asea-uninet.org/portfolio-item/affandi-museum-indonesia/>

<https://asea-uninet.org/>

### Ligatus Summer School 2019

*Julia Poirier, Book Conservator, Chester Beatty, Dublin*



As expected, the first week, 16-20 September European Bookbinding 1450-1830 was excellent. Our teacher, Professor Nicholas Pickwoad, is a world expert and scholar dedicated to the history of European bookbinding. His knowledge of the subject is impressive, and he was extremely generous in disseminating information to the group using lectures in the morning and physical examination of bindings in the afternoon. Professor Pickwoad constructed the course very carefully; we started looking at features of the book-making process chronologically, from the initial stages of folding the printed sheets of paper into book quires, to the decorated metal bosses on a leather cover, possibly the very last stage of the binding process.

In the afternoon we discussed the many binding features and techniques in more detail looking at specific examples. Thanks to the location of the summer school this year, which is richly dotted with such beautiful places (Kremmünster, Melk and Zwettl), we were granted special access to these three monastery libraries. This was a real privilege for all the participants as access to such beautiful libraries is often restricted. And of course, looking at books in close detail provides a unique opportunity to identify small differences in production and thereby perhaps to identify a place of binding production.



I feel a lot more confident in my ability to identify bookbinding structures after taking this class. It has given me the chance to learn more about specific book characteristics, some of which are common and others which are completely unique to a city or a region.

The second week, 23-27 September, Identifying and Recording Bookbinding Structures of the Eastern Mediterranean was just as inspiring. Set full time at the university, we spend the morning classes with Giorgos Boudalis, who presented his extensive research on the structure of early codices as an introduction to Mediterranean bookbinding. Following the same logical examination process of looking at the features of the book in the order it was made, we looked at the construction and specificities of Byzantine, Armenian, Syriac, Georgian and Islamic bindings. We focused our interest largely on Byzantine bindings and their evolution in time. Giorgos' passion for the endbands of these books meant we spent a good part of the course looking at variations of these fascinating features, understanding in greater detail how they were produced and how to identify them.

The afternoon classes were spent with Thanasios Velios, looking at the idea of linking data for book conservation along with how to structure a database in the hope that the information will be accessible globally. Although a little bit different from the usual book conservation course, the concept and overview of the many steps necessary to achieve this idea was very interesting.

On the final day we practiced using the Ligatus database designed for the St Catherine Monastery, using a selection of Armenian, Islamic and Georgian books that were lent to the University for this exercise.

Having both Giorgos and Thanasios at hand for specific questions regarding the book structures or technical queries with the database, we recorded the structure of a handful of books, practicing careful looking and recording the information as closely as possible.

Attending the Ligatus Summer School at the University of Donau, surrounded by motivated students and knowledgeable teachers, was inspiring. If I learned anything during those two weeks, it is that when one looks in detail at book structures that look similar, an infinite number of variations appear to be a lot more common than I had ever imagined.



#### XIV IADA Congress Warsaw 23-27 September 2019

Maja Kostadinovska, Conservator, National and University Library, St. Clement of Ohrid, Skopje, North Macedonia.

The 14<sup>th</sup> Congress of the International Association of Book and Paper Conservators (IADA) had a full four-day program and included papers on diverse topics such as “Bench conservators or middle managers”, “Materials and equipment used for conservation”, “New technologies”; and “Books as museum objects and the role of the conservator”. All of the issues and questions addressed by the conservators presenting at XIV Congress were of significance, and it was interesting to find answers and to compare practices.

I successfully presented the paper **Conservation treatment of Affandi’s “Three Beggars”** on behalf of Patricia Engel on the first day of the conference and it was received with compliments.

The presentation **Bargaining Bench Time: When Managerial Tasks Overshadow the Conservator’s Desire for Hands-On Practice** from Anthi Soulioti, the Royal College of Physicians, London, UK stood out for me. I have found that administration work can overshadow my time spent on for bench-work. However, it was another presentation by Anne Downey, American Philosophical Society, Philadelphia, Pennsylvania, US **Bench Conservator + Manager = Analog Tools You Need Now!** which showed how to use different kinds of tools to manage both time and conflicting obligations. Several tools were proposed, but I mostly liked the Tool #6: Give up perfectionism!



Two more presentations caught my attention, one was the presentation of Salvador Muñoz Viñas Senior Professor at Instituto de Restauración del Patrimonio, Universitat Politècnica de València, Spain, **The Pleural System: A Tool for Paper Flattening and Lining.**

He demonstrated a tool for the flattening and the lining of paper. An incredible solution for oversized paper artworks or posters, especially when it comes to cases where soluble inks, watercolours, tempera are used. Another similar presentation presented by Yuhui Liu who is based at the Institute of Conservation and Restoration (IBR) of the Bavarian State Library, Munich, Germany **Precise Heat-Transfer in Conservation Treatment: New Approach to Removing Old Mending Glued with Protein-Based Adhesives in Manuscripts and Rare Books** with a new developed system for removing old mending glued folios with protein-based adhesives in manuscripts and rare books without unbinding the covers.

Due to the diversity of topics covered, there is no question that this XIV Congress was informative on changes in the profession, as well as broader developments on practical treatments relevant to my work. It was attended by participants from Europe and around the world and provided the opportunity to meet and exchange ideas. The XIV Congress also had a tremendous selection of exhibitors from suppliers of conservation materials, tools and equipment and I loved visiting their stands.

## We have new national representatives

Besides the Board, there is a growing community of national representatives who maintain communication with the respective countries. The ERC now has representatives from thirty countries. A full list along with the details of the board can be found below:

<http://www.restauratorenohnegrenzen.eu/erc/Board/>

New national representatives who joined the community in 2019 are:

**Sherif Afifi (Egypt)** [CV.pdf](#)

**Namita Jaspal (India)** [CV.pdf](#)

**Ruth Tiddor (Estonia)** [CV.pdf](#)

**Birute Giedritiene (Lithuania)** [CV.pdf](#)

**Anne Nadolny (Germany)**

**Željko Mladićević (Serbia)**

## ERASMUS+

Since 2012 ERC has developed a strong ERASMUS program.

<http://www.restauratorenohnegrenzen.eu/erc/Courses/>

This mutually beneficial arrangement provides essential help for the ERC and the students benefit from their experience.

During the summer of 2019 ERC was host to Sara Katati Bote

\*Editor's note: This is an edited summary of the formal report submitted after the ERASMUS+ internship.

---

### Report Summer Internship (ERASMUS+)

Sara Katati Bote

With the aim of learning to develop concepts of conservation of written and graphic heritage that are appropriate to the needs of the heritage elements themselves, I have participated in the ERASMUS+ mobility program (July to September 2019). The internship took place at the European Research Centre for Book and Paper Conservation-Restoration (ERC), Centre for Cultural Property Protection, Department for Building and Environment, located at the University for Continuing Education (DUK) in Krems, Austria, under the supervision of Dr. Patricia Engel.

At the beginning of this mobility I already knew that preserving our written and graphic cultural heritage is a complex challenge. Three months later I am not mistaken when I say that, in our European environment, the proper comprehensive preservation of written and graphic heritage is essential.

I have come to this conviction after being involved in several activities of various kinds, the core of which has been the conservation of books and graphic art, and which have been oriented towards research in this field. These have been the activities and tasks carried out:

- ❖ **Development of a lecture on the procedures for handling archival material, elaborated for the Archive of the City of Krems volunteers**
- ❖ **Preparation of the Ligatus Summer School international course,**
- ❖ **Involvement in the conservation project “WAYANG BEBER, a unique cultural heritage of Indonesia**
- ❖ **Collaboration in the conservation labours of St. Florian Abbey library**
- ❖ **Assistance in the preparation for the Ink Development of MuLiBiNe.**
- ❖ **Cataloguing and inventory of books donated to the European Research Centre for Book and Paper Conservation (ERC).**
- ❖ **Bibliographic searches for research projects**

I have been able to grasp the importance of organising, communication and relations, both internal and external, between departments. The wealth of opinions among colleagues and experts provides a broad view of the possible ways to resolve all sorts of doubts that arise in the course of any project. Another lesson learned, in this regard, is that change is an expected part of the project, and that sometimes these changes are caused by necessary modifications to the project design.

Generally speaking, by reflecting on what had to be done, what steps had to be followed, with what procedures, how to do it and why in a specific moment, I have been able to acquire new skills by analysing problems and finding effective solutions; effectively determining the objectives and priorities of the task to be carried out; defending and transmitting ideas and collaborating in a team.



*Primadona Hapsari and Sara Katati Bote, during the conservation visit to St. Florian Abbey library.*

Specifically, I have acquired knowledge of other areas related to studies: research, teaching or archiving.

Regarding to research, I must highlight the central role it plays in acquiring new knowledge and expertise, both theoretical and practical, coming from different disciplines, because it allows us to develop curiosity and establish contact with reality

and the knowledge acquired. To investigate means to search and discover, in order to elaborate new theories in different disciplines or to modify the existing ones. But this ability is one more strategy in the learning process, it is the basis of education and it is a resource in teaching. In particular, research is fundamental in heritage libraries, and the conservation of that heritage, including digitization, must be wisely planned in order to achieve the dissemination of those original works that are so eagerly kept.

In relation to teaching, I have seen that the difficulty of teaching in a heterogeneous group can be overcome if teaching is adjusted to the capacity of each one and the necessary help is provided so that each one develops its maximum capacity.

On a personal level, this time has helped me to understand more clearly and quickly the heritage funds, to gain this work experience and to estimate, through contact with the works, other aspects of culture such as cultural identities or intangible heritage. The internship has made a contribution in the sense of adapting the working method to an institution that has allowed me to work comfortably and to which I am grateful for the opportunity. I consider it to be a complement to university education and I trust that also for my future labour market insertion, as well as a priceless and enriching experience.

## Update on the Facebook Page – A Short Note

*Pascual Ruiz Segura*

One year ago, the European Research Centre for Book and Paper Conservation-Restoration decided to open its official Social Media pages on Facebook and Twitter. Beginnings are always tough and, unfortunately, the Twitter page has been closed due to it didn't accomplish the expected results and it was decided to focus on the Facebook page, which is steadily growing and in good shape!



Throughout the year, our posts have been introducing the official website of the ERC and its sections, but the main task has been to update readers with the information about a wide range of activities organized by the ERC.

We included the “Ink Corrosion conference-ICC”, the conferences attended by the members of the ERC, the welcome to the first scholars from the SP24, the meeting with Ibu Kartika Affandi the ambassador of the Republic of Indonesia and his Excellency Dr. Darmansjah Djumala, the Ligatus Summer School 2019 and the Ink making course taught by Mag. Dr. hab. Patricia Engel, which achieved the highest numbers so far in terms of people reached (403) and engagements (87).

We have currently 231 followers with 212 likes and we would like to thank everyone for the support. We would like to encourage everybody to help us to grow the page by sharing it in social media. In addition we welcome pictures and information on all sorts of relevant conservation activities, especially if they have direct connection with the ERC.

## The new link – the ERC Library

Shortly after the Centre was founded in 2011 we received donation of a collection of books, this continued for a few years. We are now able to provide a list of the books and will have them online soon. There are some very rare titles among them. We encourage you to use the list to ask us even for extensive loans.

At the same time we encourage you to donate to us books and papers, which we are able from now on to list immediately and keep our stock updated. This way we will soon have a very special and large library for the benefit of us all.

Follow the link:

<http://www.restauratorenohnegrenzen.eu/erc/Library/>

The screenshot shows the website for the European Research Centre for Book and Paper Conservation-Restoration. The page is titled "Library" and contains a list of publications. The list includes the following columns: Code, Format, Title, Author, Number, Place, Year, ISBN/ISSN, and others. The publications listed include:

- Code 1: Book, cent'anni di passi della prevenzione in biblioteca, I, Murafo, Paola F.; Di Febo, Assunta; Egidio, Giulia, Roma, 2008, ISBN: 88-85298-06-1
- Code 2: Newspaper, "Mikrodruck, Zeitschrift für Druckgraphik und visuelle Kultur", Vienna, 2013, ISBN 1991-8366
- Code 3: Book, Atlas of Damage Descriptions of archival Materials, National Archives of Estonia, 2013, ISBN 978-9985-888-0
- Code 4: Ppt, How to be made real japanese paper, - - - - - Publications of the Archives of the Republic of Slovenia, Volume 15, Ljubljana, 1997, -
- Code 5: Journal, Writing and image preservation, conservation, restoration, Publications of the Archives of the Republic of Slovenia, Volume 15, Ljubljana, 1997, -
- Code 6: Book, naturwissenschaftenliche blick, Der Weber/Dopfer, Simon, Vienna, 2009, ISBN 978-3-200-01699-6
- Code 7: Journal, The Paper Conservator, The Journal of the Institute of Paper Conservation, Volume 21, Budaest, 1997, ISBN 0309-4227, -
- Code 8: Journal, Restaurator, Zeitschrift für Kunsttechniken, Restaurierung und Museumsfragen Mitteilungen der IADA, IADA, 2, Munich, 1992, -
- Code 9: Journal, Restaurator, Zeitschrift für Kunsttechniken, Restaurierung und Museumsfragen Mitteilungen der IADA, IADA, 6, Munich, 1994, -
- Code 10: Journal, Restaurator, Zeitschrift für Kunsttechniken, Restaurierung und Museumsfragen Mitteilungen der IADA, IADA, 5, Munich, 1994, -
- Code 11: Journal, Restaurator, Zeitschrift für Kunsttechniken, Restaurierung und Museumsfragen Mitteilungen der IADA, IADA, 1, Munich, 1999, -
- Code 12: Journal, Restaurator, Conservation-Restoration Bulletin "Dimitriez Gatac" National Village Museum, 4, Bucharest, 2011, ISBN 2045-2992, -
- Code 13: Book, Bill a head and Herald, The History of Paper and Materials from the Middle Ages to the Modern Period, - - - - - Stuttgart and Vienna, 2009, ISBN 978-3-00-026890-8
- Code 14: Book, Fluffy stuff, Integrated control of mould in archives, Broekhof, Roger W.; van Zanten, Bert; den Teuling, Arnold, Amsterdam, 2007, ISBN 978-90-72805-51-2
- Code 15: Book, Report on preventive conservation of documents in Finland, France, Italy Spain and the United Kingdom, Istituto centrale per la patologia del libro, - - - - - Rome, 2004, ISBN 88-85298-03-7
- Code 16: Book, Scienza e ricerca per i beni culturali: microscopia elettronica a scansione a microcanali, Istituto centrale per la patologia del libro, - - - - - Rome, 2008, ISBN 978-88-492-1431-4
- Code 17: Book, Libri e carte: restauri e analisi diagnostiche, Istituto centrale per la patologia del libro, - - - - - Rome, ISBN 978-88-492-1133-1
- Code 18: Book, Applique Mikroskopien, Laloner, Wilde, - - - - - Germany, 1980, ISBN 3-88259-183-9
- Code 19: Book, Paper as a Medium of Cultural Heritage, Archaeology and Conservation, Istituto centrale per la patologia del libro, - - - - - Rome, 2004, ISBN 88-8298-02-9
- Code 20: Book, Musei dell'Istituto centrale di patologia del libro, II, Istituto centrale di patologia del libro, - - - - - Rome, 2001, ISBN 88-8298-01-0
- Code 21: Journal, Mergon, - - - - - St. Pölten, 2014, 91200016400303
- Code 22: Book, Mirovna znanja kuharstva v domu Hvaladobroslavci, Inocor, Benevolus, - - - - - Czech Republic, 2001, ISBN 80-238-6530-7
- Code 23: Journal, Revista română de conservare și restaurare a cartii, - - - - - 1.2, Bucharest, 2009, ISBN 2067-2624
- Code 24: Journal, Revista română de conservare și restaurare a cartii, - - - - - 1.1, Bucharest, 2008, ISBN 2067-2624
- Code 25: Book, Restaurationspolitik, Österreichische Kulturdenkmale im Baden-Württemberg, - - - - - Lindenberg, 2009, ISBN 3-9370-244-8
- Code 26: Book, pensiero di Cesare Brandi dalla teoria alla pratica, II, Associazione Giovani Seco Suardo, - - - - - Rome, 2000, ISBN 978-88-6336-006-9
- Code 27: Magazine, vjendros natural heritage of Croatia, The Croatian National Tourist Board, - - - - - Zagreb, 2009, -
- Code 28: Magazine, vjendros natural heritage of Croatia, The Croatian National Tourist Board, - - - - - Svetla Medelja, 2010, -
- Code 29: Magazine, upgrade, - - - - - Krems, 2014, ISBN 1862-4154
- Code 30: Brochure, Lower Austria Contemporary, - - - - - St. Pölten, 2014, -
- Code 31: Magazine, upgrade, - - - - - Krems, 2014, ISBN 1862-4154
- Code 32: Magazine, upgrade, - - - - - Krems, 2014, ISBN 1862-4154
- Code 33: Magazine, info, - - - - - Viena, 2014, ISBN 2309-0723
- Code 34: Book, Taschenlexikon für Kunst, Schäffer, Emeritz, 13, Germany, 1983, -
- Code 35: Book, Svaneti museum of history and ethnography, Nestia, Utgulii, - - - - - Tbilisi, 2009, ISBN 978-99940-980-8-8

## Evaluation of restoration and conservation methods for cultural heritage and creation of a decision matrix for archives, librarians and restorers

### Survey - can you help? Deadline: 15 Feb 2020

Conservation of cultural heritage is an important task to save historical documents and to make them accessible for users. The available methods as well as the material is very diverse and includes small-scale manual up to industrial scales.

For the evaluation of previous methods, we are carrying out a database-supported survey and analysis of the experience in an international field

The aim of the survey is to define success and evaluate results of the conservation methods.

Based on your answers, we would like to plan the next steps and work towards the development of specific support that is designed in a way archives likely need.

Find the questionnaire here: [doc](#) or [pdf](#)

Please send your completed survey to [IVEK@hs-hannover.de](mailto:IVEK@hs-hannover.de)



---

## Impact of old conservation methods on leather and parchment

Tuuli Kasso

[tuuli@palaeome.org](mailto:tuuli@palaeome.org)

---



On June 6-7<sup>th</sup> 2019, the ICOM-CC 11<sup>th</sup> Interim Meeting of the Leather and Related Materials Working Group was held at the Musee du Quai Branly in Paris, France.

As a part of ICOM-CC, the group and the conference aimed to promote a diffusion of knowledge for the conservation of skin-based objects and gathered professionals conservators, curators, historians, scientists together.

Member of Beasts2Craft, PhD Fellow at the University of Copenhagen, **Tuuli Kasso** presented the paper "**Impact of old conservation methods on leather and parchment**" **Engel et al**, on the first day of the conference, and it was received very positively.

One of the key topics raised during the conference was the unintentional contamination by conservation treatments when conducting species identification with ZooMS, this was noted by two other papers in the conference as well. The note by Collins, Engel et al. that applied glues for parchment should be adverse from the species (e.g. fish glue for mammalian products) not to distort the analysis was taken with great interest, as usually it is custom to choose conservation treatments or restorative materials in liaison of the main material.

---

## Research

### **Archive and Museum - Conservation concept for paintings on canvas and paper, notebooks, drawings, glass plates, photographs, plans and films of the Museum Affandi and the archives of the temple of Borobudur UNESCO Cultural Heritage site listed as an UNESCO Memory of the World in 2017 as a joint training with building up the department of conservation-restoration in ISI, Yogyakarta (2019)**

ASEA Uninet

Main objective of the project is to work on preservation techniques in combining European expertise with local approaches in dealing with the hot and humid climate in restoration and natural hazards. Preliminary projects in cooperation with the Museum Affandi focused on experimental case studies on preservation techniques, building physics and on the reintroduction of traditional methods for insect and mould protection.

This goal is supported by a three-step approach:

- presenting the state of the art of conservation -restoration and preservation of archival material, library material and paintings on paper in Europe
- this knowledge is adapted and customized by the professors of the universities in Indonesia
- best practice examples are created for the time being which are designed in such a way as to allow Indonesian scholars to adopt and apply the methods later and develop new methods themselves where needed.

### **WAYANG BEBER, a unique cultural heritage of Indonesia – conservation concept (2019)**

ASEA Uninet, SP24

*Wayang beber* is an important element of Indonesian cultural heritage which is unique to Indonesia, being one of original creations of the ancient Indonesian culture. It is a variety of theatrical show referred to as the *beber puppet* (**beber** meaning “**unrolling**”, **wayang** meaning “**puppet**”) because, unlike the better known *wayang kulit* (the famous shadow puppets made of skin) it is not based on the use of puppets representing persons but on pictures painted on flat surfaces and mounted on sticks that are unfurled or spread out while the stories are told. So, the word “beber” in *wayang beber* refers to the way the presentation of the puppet is spread in front of the audience because the material used for this kind of puppet show is Javanese roll. In Javanese it is specifically referred to as “**dluwang**”, which is a fine writing material with a wooden or similar appearance made of the inner layer of mulberry bark (*broussonetia papyrifera*). Some parts of the puppet have been torn and may become even worse if the scrolls are continuously opened for exhibition. Additionally, the colors in the picture of each wayang beber scroll are increasingly fading. So it is necessary to make an effort to save this puppet from further damage or extinction. Professional conservation seems to be the best solution for this problem. The project aims to:

1. identify a conservation concept for the *wayang beber*,
2. perform the conservation.

During July and August, the ERC hosted an in depth study trip.

Read her full report [here](#).

For more information about these research projects and other projects that ERC are involved with check out the Research page on our website:

<http://www.restauratorenohnegrenzen.eu/erc/Research/>

## 2. ARTICLES

*Adelheid KRAH<sup>1</sup>, Stephan KELLNER<sup>2</sup>, Ulf RÖHRER-ERTL<sup>3</sup>*

*1 Department of History, University of Vienna, and Institute of Austrian Historical Research,  
University of Vienna Austria*

*2 Bavarica Department, Bavarian State Library Munich, Germany,*

*3 Bavarian State Library Munich, Germany*

### **The “Libri censuales” – Freising manuscripts from conservation to digital edition**

#### **Abstract**

When it comes to the publication of an edition, in times of the digital turn, with all its changes also for scientific practice, there is always the fundamental question whether to aim at a printed publication or a digital one. Not least, a digital provision on the internet makes it more easily traceable as well as applicable so that it can have a more wide-spread impact than a printed publication. By using the “Libri censuales” of Freising from the Bavarian State Archive in Munich (BayHStA HL Freising 6) as an example, this essay aims at showing that while modern possibilities of text exploitation can complement traditional knowledge and skills, they cannot replace them. In the case of the Freising manuscripts it was decided from the start that it would be a digital edition in combination with digitization and online provision of the manuscripts. Here the expertise of the Bavarian State Library in Munich (BSB) with their Munich Digitization Center (MDZ) was offered together with the Bavarica Department as a partner.

**Keywords:** digitization, online-edition, archival research, book-conservation, digital humanities, Freising deeds, medieval manuscripts, “Traditionsbücher”, chartulary books, feudalism.

## Introduction

Through the modern digitization of codices and their online provision in the OPAC of libraries and archives, a different approach to the material as well as to the content of manuscripts has been conceived. By zoom functions, one can determine the paper fabric, the used ink and the colouring of the initials, detect customs and conventions of script, assign later additions to writing hands and detect the habits of the scriptoria. But these novelties on their own are not sufficient for palaeographic and codicological studies. They simply add more to the traditionally established knowledge of the material of the respective text type.

By using the Libri censuales of Freising from the Bavarian State Archive in Munich (sigle BayHStA HL Freising 6) as an example, this essay aims at showing that while modern possibilities of text exploitation can complement traditional knowledge and skills, they cannot replace them. The Libri censuales of Freising is an essential part of the collection of manuscripts from Freising that were compiled as books for the official records of the administration of the diocese and reflect the economic growth of the clerical landlords of Freising from the early to the high Middle Ages. Within this process, the Libri censuales takes up a special role because of the recorded interplay between the dependent workforce and their feudal lord over an extensive period of time. The layout of the text in the Libri censuales is singular and vivid. There exists one basic set of the text in the same form of script and a multitude of additions, amendments, deletions, erasures as well as added pieces of paper.

This variety documents the diverse economic reality of an unfree class of workers that changed consistently: through the birth of children, death, marriages and also through changes of class and social standing of higher people and free ones into dependency and unfreedom. The Libri censuales of Freising was an administrative instrument which was stored in the chancellery that became part of the vestry and which was also taken to visitations in order to inscribe additions – frequently by an uncontrolled hand of a subordinate of the official cleric on site.

## The collection of the Freising Manuscripts – From Cozroh codex Liber traditionum to Libri censuales

The collection of the Freising manuscripts (Traditionsbücher, chartulary books, urbaria and accountant books), which is preserved nowadays in the Bavarian State Archive in Munich, transfers the administrative and tenorial history of the bishopric of Freising from the beginning of its history on the castle hill of the Agilolfinger dukes in seventh and eighth century. In order to save the countless individual documents of the traditional deeds from loss or fabrication, a chartulary book of the tenorial traditions of Freising and other business transactions was compiled around the year 824 during the episcopal term of Bishop Hitto of Freising (810/11-835) by Cozroh, the chief scribe and head of the episcopal chancellery and scriptorium. The reasons behind its compilation were organisational adjustments in the episcopal archive, most likely after the role model of the Carolingian chancellery in Aachen; to which good relations are handed down.

This well-known codex, which is nowadays stored in the Bavarian State Archive under the sigle HL Freising 3a, was systematically stored with registers of the charter stocks of the individual bishops and furnished with consecutive numbers of the copied documents; it was gradually continued until the year 853. However, it was important to record the property-giving personalities and their memoria through prayers in Freising's episcopal church or in its dependent foundations on the countryside through proper documentation, together with the lease contracts that were contracted with them and their descendants and which were in their entirety captured in a codex in a chartulary manner. Thereby, one can observe the tendency of the bishops of Freising to gain as much property as possible through donations and precariat-contracts, by issuing gift- and usage contracts for the families of the donators permanently. Only rarely there are parts in the Cozroh-Codex that mention people who worked on the property as free or unfree servi/ancillae (workforce), who got another feudal lord by endowment – later on also the cathedral chapter as an institution.

In the middle of the ninth century, the way of how the bishopric gained land changed; there are only a few donation charters, while property was apparently



exchanged. This codex commutationum (nowadays stored in the Bavarian State Archive under the sigle BayHStA HL Freising 3b) contains primarily entries on exchange deals around the time period between 819 and 1039 and was installed around the middle of the eleventh century. The individual fascicles of the codex were later on bound together with other older chartulary books and some original charters, among them also a marriage contract from a steward of Freising, which was issued in 1070.

## The Libri Censualium

The growing property of the clerical feudal lords reached at this time into the Danube region, where the extraterritorial property in the Wachau valley was located, as well as into the Slovenian area. Who cultivated it?

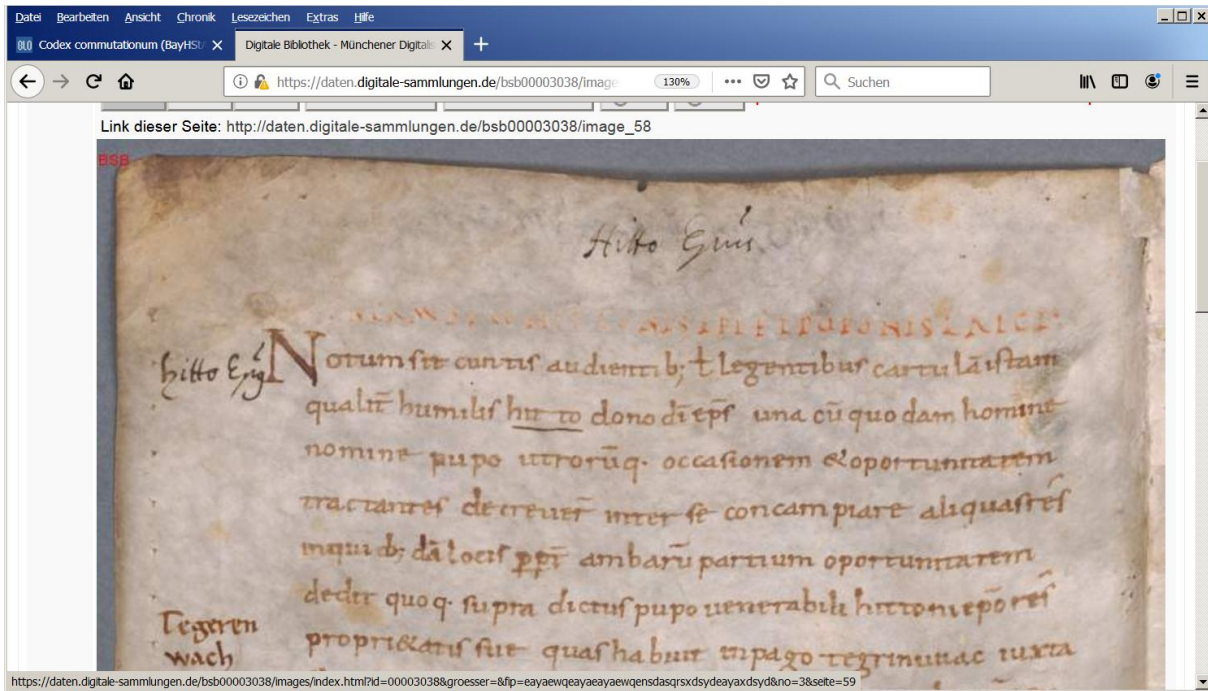

**Fig. 1** The beginning of the oldest fascicle of the exchange book, issued under Bishop Hittos of Freising (811-836), HL Freising 3c, fol. 20v.

Regarding this question, the so-called Liber censualium, which is today stored in two different places, provides more information: the first part is in the Bavarian State Archive under the sigle BayHStA HL Freising 6, part two is located in the Duke August Library Wolfenbüttel under the sigle Cod.Guelf. 9. 7 Aug. 4, Heinemann-Nr. 2988, Codex traditionum ecclesiae Frisingensis. It provides multiple name references to male and female workers, their children and kindred, who cultivated the property of Freising. Since antiquity, ‘Censuales’ had been mostly unfree laborers or tenants, who went under the protection of a lord in order to avoid the payment of interest; this Roman tenurial agricultural system was taken up by the Christian episcopal sees and was developed further.

During the pilgrim and crusader period to Jerusalem from the last third of the eleventh century onwards, bishops became essential protectors of the population; especially free and noble women, whose husbands had gone on crusade, subdued themselves and their property under the protection of the Bishop of Freising and the patron saints of the diocese – Saint Mary and Saint Corbinian and chose unfreedom voluntarily. Thereby, their property was obtained and given to them from the bishop for farming it at their own responsibility for an annual rent around one, three, five or six solidi – this was also granted to their children by contract.

A majority of these single contracts, which vary content-

wise and could be compiled individually, were copied in the Libri censuales of Freising and were collected in a chartulary manner. With such contracts all unfree laborers had to be registered with their first name; they were assigned to the property by a mention of the place name or a description of the location. Such spatial name lists were continued by the episcopal administration in the time thereafter and amended by the adding of new names of children or additionally gained workforce through kinship, exchange or purchase. The different handwritten amendments beside or under the core text in the Libri censuales transmit this procedure.

Furthermore, single sheets of parchment were filed into Freising's Libri censuales: Authentica of the contracts or Noticiae, which mean protocol contract texts, which documented the administrative steps thoroughly: from the compilation of the note over the deed to the copy – from the copy to the adding of personal names to the update of the official register. Thus, there does not exist a completed chartulary book, but rather a dynamic work-in-progress book of the administration that was administered from the end of the eleventh century until the thirteenth century.

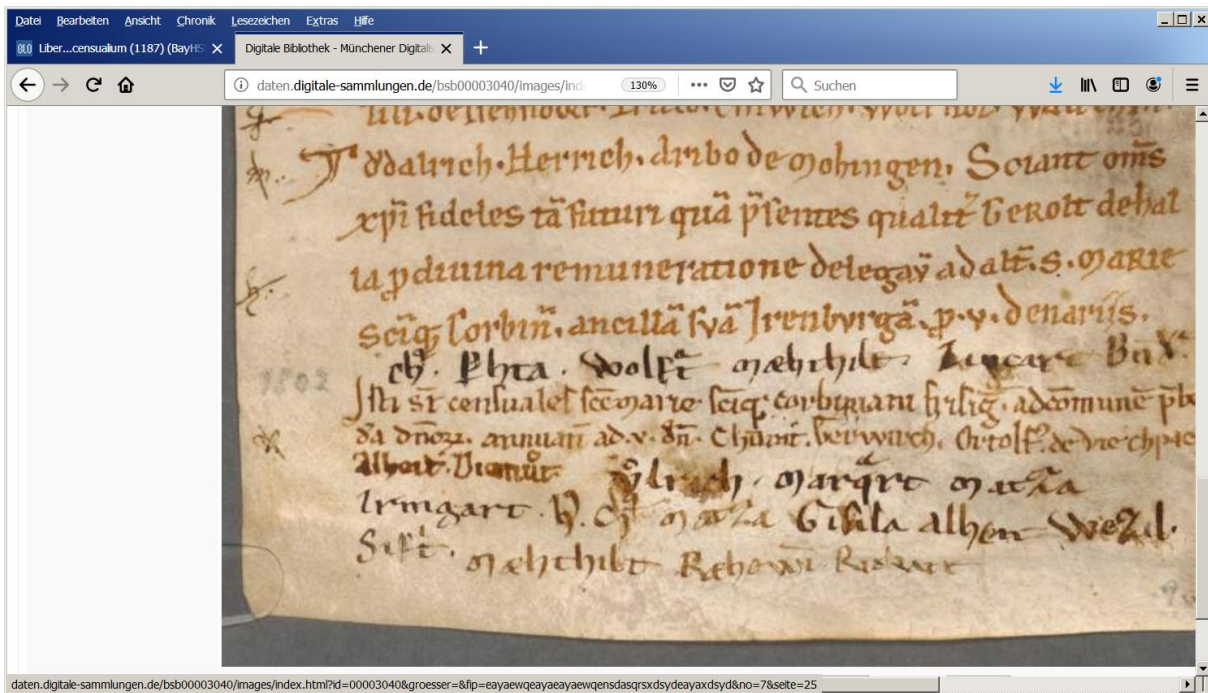

**Fig. 2** HL Freising 6, fol. 9v, bottom third. Main text and additions by various hands.

The Liber censualium of the Bishopric of Freising is an excellent source for the social history of the Bavarian and Austrian region during the high middle ages. Yet, also the high nobility is represented, for instance through famous Bavarian earls like Otto I. of Scheyern (1072) and his son Otto II. (1072-1110), both were stewards of the Bishops of Freising and of the cathedral chapter; even Gebhard of Sulzbach traded unfree servants, 'servientes', for his salvation to Freising in 1187.

Moreover, the aristocracy protected members of the unfree ministerial families and their wealth from the claims of other family members via this transmission

to Freising. For the issuing of lease contracts, text models were used which could be extended or shortened individually for the chancellery so that it would suffice for the various legal implications. Therefore, there existed a whole collection of formulaic frameworks.

### Why two codices? – Lost and found.

The documents of the previously mentioned old and precious official registers of Freising (Freisinger Amtsbücher) were edited by Theodor Bitterauf in a chronological order that was created by him for the edition: "Die Traditionen des Hochstifts Freising, part

1 (744-926), München 1905, part 2 (926-1283), Munich 1909”. This method does not correspond to the installation of the codices and mirrors these only partially when the contexts of the dated documents in the edition were preserved; but most of the time, the edition follows an artificial order along the terms-in-office of the bishops of Freising: undated manuscripts are assigned to dated charters for unreasonable causes. This is also valid for the two parts of Freising’s *Libri censuales*.

While the codex that is located in Munich was edited in accordance to its context because of the dating of the script and of single charters by Bitterauf at the end of part 2 - with a re-arrangement of the documents – he mingled the texts of the second part of the *Liber Censualium*, the one which was situated back then in the Herzog August Library in Wolfenbüttel, and selected them according to his chronological editing system after the terms of the bishops of Freising with manuscripts from different origins. Concordances make the connections between the edition and the manuscripts accessible in a tabular manner. This technique in editing at the beginning of the twentieth century was elaborate and demanded a high degree of accuracy; through this, the “oeuvre” of the respective bishop and his contribution should be documented chronologically in the edition in a comprehensible way.

This accuracy resulted in the benefit that Bitterauf included both parts of the *Liber Censualium* in his edition and thus analysed the part of the manuscript that is stored in Wolfenbüttel. Despite the fact that he did not realize that he was dealing with only the first part of one coherent manuscript, but writing instead of two distinct manuscripts, his studies are exact and reliable (see Bitterauf, *Traditionen* 1, XXXIII-XXXVI).

#### *Description of the manuscript HL Freising 6*

At the occasion of its digitization and online provision in page version in the tool of the Bavarian Federal Library Online (Bayerische Landesbibliothek-Online, BLO) at the Bavarian State Library (Bayerische Staatsbibliothek, BSB), the manuscript had been applicable and was analysed by myself. The bundle of sheets of parchment, including the manuscript description by the archivist Löhr for the Royal General Reichsarchiv (Königliches allgemeines Reichsarchiv)

from the 5<sup>th</sup> of April 1878 on cohesive sheets of paper, has been stored since then in a specifically designed cassette in the Bavarian State Archive (Bayerisches Hauptstaatsarchiv, BayHStA). The manuscript consists of 49 folia: for the *Zensualen-Traditionsbuch* for the cathedral chapter from fol. 2 to fol. 34 with three complete layers, fol. 2-25, the incorporation of a double sheet as fol. 26 and 33 and one incomplete fourth layer. On fol. 34v line 4, a fringe cross marks the end of the chartulary book. Folia 35 to 49 are a collection of fragmentary documents, which apparently did not belong to the manuscript, as Karl Meichelbeck OSB (1699-1734) wrote in his ‘*Historia Frisingensis*’ between 1724 and 1729. Fol. 1 is a flyleaf including the previously eliminated text of the Gospel of John (Joh. 4, 10-33) from another manuscript: Jesus with the Samaritan woman at the fountain of James.

This part of Freising’s *Libri censuales* contains over 100 individual traditions in the main text, most of them in the length of two to seven lines. It was written with brown ink by two hands at the end of the twelfth century, with 32 and 46-48 letters per line. At the bottom end of the page, it shows that all pages were continued further in the writing through further entries of the *Censuales* contracts from the twelfth and thirteenth century and through further name lists. The installation of such a register book could have been commissioned due to contact with the episcopal chancellery in Regensburg in the year 1187. Responsible for this was most likely Conradus Sacrista, who had been the head of the Freising Scriptorium back then and was compiling a copy of the ‘*Liber traditionum*’ of Cozroh himself in the style of the time of Emperor Frederick Barbarossa. The oldest copied texts reach more than three generations back into the term of Bishop Meginwards (1078-1098). With the installation of the registrar book, it had been intended to create a ‘family register’ for the families who stood under the protection of Freising, on the one hand to retain the origin and the transfers of rights, on the other hand to allow for a continuation of the legal binding to the next generation and to hold them liable. [see Wild (2006) *Libri censualium*, as well as the manuscript description by Krah, Adelheid, Hummer, *Liber...censualium* (1187) BayHStA HL Freising 6, digital edition, Link: <https://www.bayerische-landesbibliothek-online.de/libercensualium>].

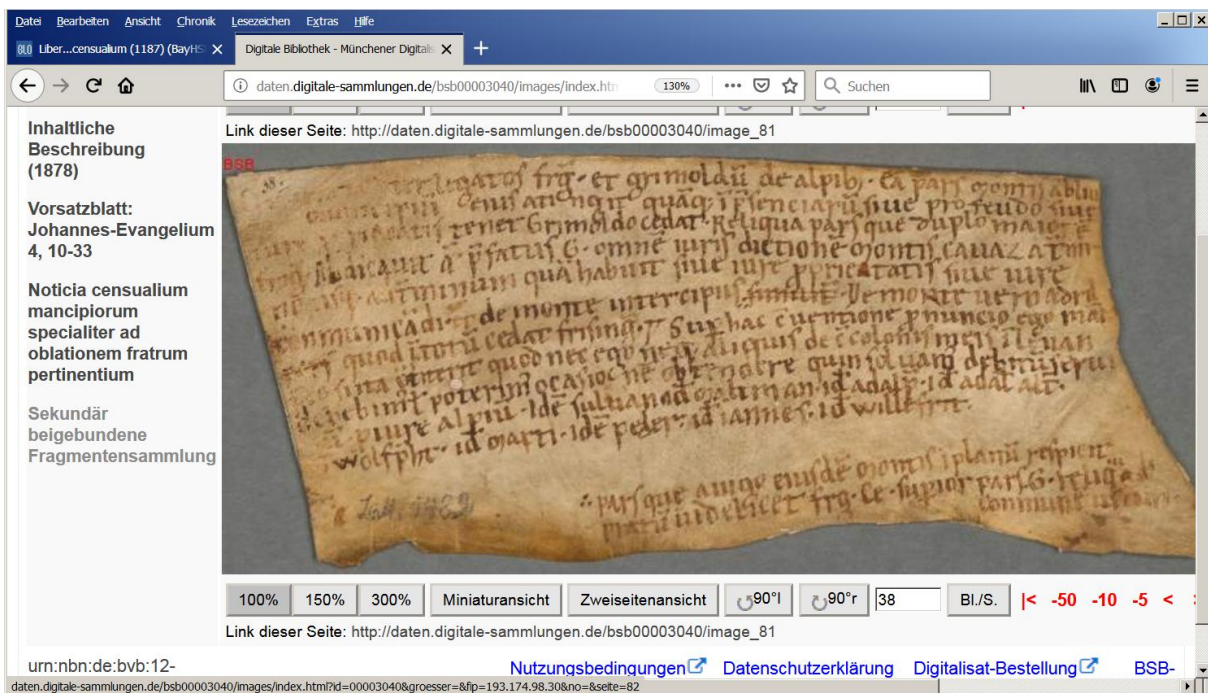

**Fig. 3** HL Freising 6, Collection of fragmentary documents fol. 38, Authenticum

**To the second part of the Freising Libri censuales: Codex traditionum ecclesiae Frisingensis (Cod. Guelf. 9.7 Aug. 4°; Heinemann-Nr. 2988)**

The 70 folia of the codex with provenience in Freising were contained in a black leather cover. Together with this book cover and an older description on paper, as well as a short manuscript description by Heinemann, they are available as digital facsimiles in the manuscript database of the Digital Library of the Herzog August Library Wolfenbüttel online: <http://diglib.hab.de/?db=mss&list=ms&id=9-7-aug-4f&lang=de> (accessed 18 July 2019).

In the right corner of the pre-bound page, which was placed there to protect the following text, the price of two thalers for the purchase of the manuscript is inscribed, most likely by the hand of Herzog August the Younger himself, who aimed at expanding his library in Wolfenbüttel to one of the biggest libraries in Europe in the 17<sup>th</sup> century by largescale purchases of books. The red stamp on fol. 2 and fol. 70v contains the eagle of the Biblioth que Imperiale in Paris, but the

manuscript had been re-stamped after the return to the library in Wolfenb ttel with their own stamp, which shows that the codex belonged only for a limited number of years to the library of Napoleon Bonaparte (see Bitterauf 1, XXXIII).

The manuscript consists of four parts and incorporated pages; the documents date from 957 to 1261. Content-wise remarkable texts, such as lengthy disputes fought by opposing inheritance communities, which had been rolled up several times, such as in the text on fol. 45, are flanked by short texts on subjects of interests on the property of Freising or simply by name lists. The work of the previously mentioned head of the chancellery of Freising, Conradus Sacrista, is featured in several documents. He was responsible for the candle-illumination of the cathedral and took the funds of the wax interest, as it is mentioned on the documents on fol. 43 or on fol. 59v. An accurate analysis of the manuscript cannot be done due to the lack of space. This will be part of the preface of the planned online edition of the texts on the manuscripts.

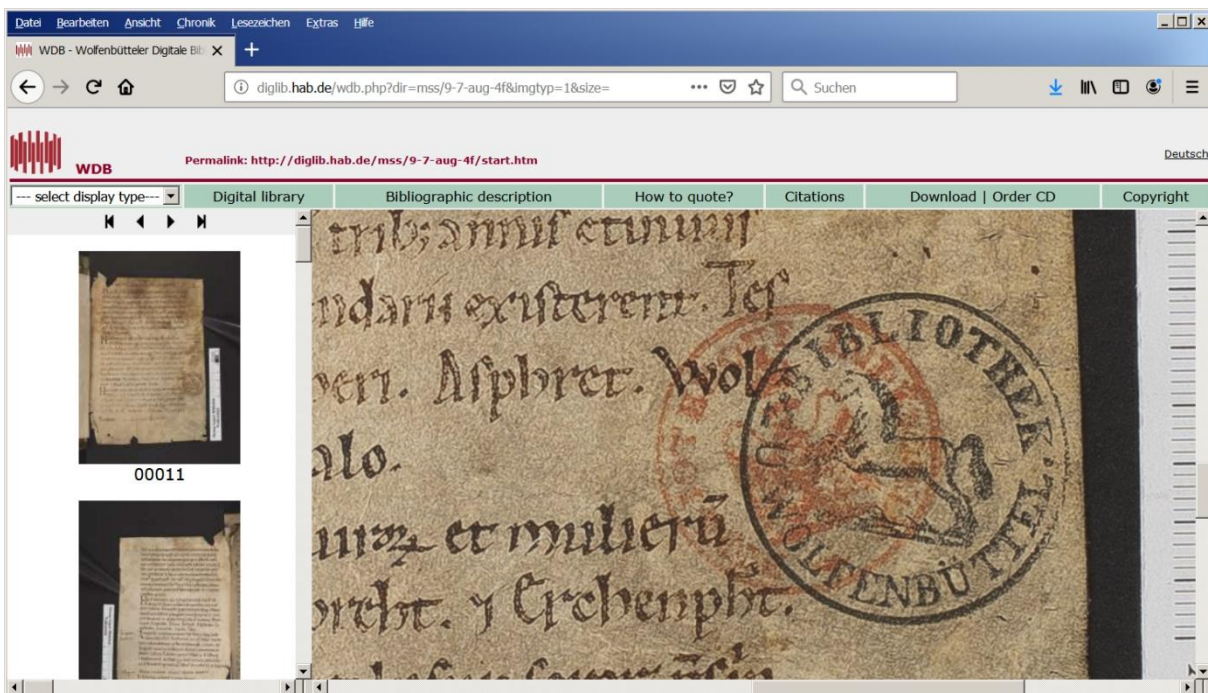

**Fig. 4** Herzog August Library Wolfenbüttel Cod. Guelf. 9.7 Aug. 4, fol. 2.

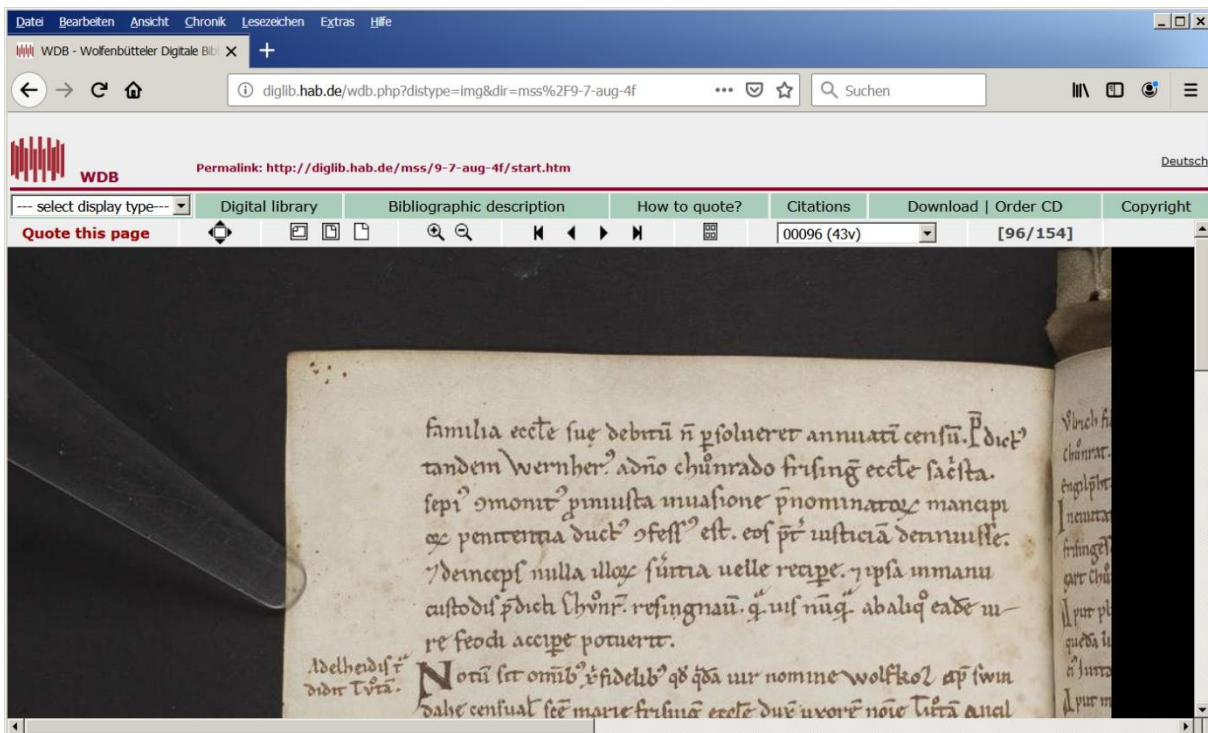

**Fig. 5** Herzog August Library Wolfenbüttel Cod. Guelf. 9.7 Aug. 4, fol.43, in line 2 and 6 Conradus Sacrista is mentioned as custos, administrator of the finances of the bishopric.

### **From the digital facsimile to the online edition: The Liber Censualium in the Bavarian Federal Library Online**

When it comes to the publication of an edition, in times of the digital turn, with all its changes also for scientific practice, there is always the fundamental question whether to aim at a printed publication or a digital one. Both forms have advantages but also disadvantages. Digital editions enable the searching of text and comments, the precise linking to digitized versions of the issued role models, further documents and digitized literature; a digital edition can incorporate new information, can grow and become a nucleus of whole networks of knowledge. Not least, a digital provision on the internet makes it more easily traceable as well as applicable so that it can have a more wide-spread impact than a printed publication.

In favour of a printed publication speak the longevity of the medium book, a (felt and real) significance of the effort of the editing process and a justified value, not least because of the fixation and ongoing preservation of the personal contribution of the researcher.

Especially the question of longevity is one of importance. The constant alterations of digital programs – no matter which sort – are inherent, imply a regular recurring obligation to update and change programs, by which the original data changes accordingly or has to be adapted. Additionally, the digital data is subdued to fault and decay after a respective amount of time. Not without reason, the question on long-term archiving has developed into one of the major questions when it comes to data, if we do not want the digital age in the long run to become the age of lost data.

In the case of the Freising manuscripts and Traditionsbücher it was decided from the start that it would be a digital edition in combination with a digitization and online provision of the manuscripts. Here the expertise of the Bavarian State Library in Munich (BSB) with their Munich Digitization Center (MDZ) was offered together with the Bavarica department as a partner. Subsequently, the scan centre of the MDZ took responsibility over the digitization of all manuscripts stored in the Bavarian State Archive, while the web portal of the Bavarian Federal Library Online was chosen as a presentation space for the manuscripts and the edition.

The Bavarian Federal Library Online (BLO) is a central academic information portal for the humanities on Bavaria that had been established from 1999 onwards and went online in 2002. The as a co-operation project of countless Bavarian cultural institutions under the supervision of the Bavarian State Library planned portal represented in its entirety as well as in its single components (for instance digitized scientific journals with Moving Wall, consequent usage of personal normed data – PND/GND, geo-referenced maps, as well as continuous links of content with a location data base) the oldest and for a long time also the most innovative federal portal of the humanities in Germany and beyond.<sup>1</sup>

With the digital edition of the Liber Censualium and with the main focus on the “Freising manuscripts (Traditionsbücher, chartulary books, urbans and accountant books)”, the BLO for the first time took up a digital-edition project in their inventory. The digital provision of the edition had to be executed with limited resources so that initially conceived further plans like the highlighting of edited passages in the digitized material of the manuscripts could not be conducted. Also, an until 2009 designed XML-featured digital edition of Bitterauf’s traditions could not be realized because of that.

The open source CMS Joomla!, which has been the basis of the BLO up until today, is a flexible system that allows within its limitations for large open spaces in programming. The strongest of these limitations is a restriction of the number of html characters per page.

For the realization of the digital edition of the Liber Censualium, the manuscript was subdivided into sections that were time-consumingly ‘translated’ into html afterwards. This included graphic elements and preview images as well as an extensive installation of anchors (skip marks) that enable the digital activation of each tradition and each footnote via a link. Additionally, accurate page links on all addressed references in the text in different manuscripts and prints, as long as these are digitally available. Finally, also pdf-files with research literature were incorporated.<sup>2</sup> The edition, which has gradually gone online in today’s form since 2009, has until nowadays

<sup>1</sup> Kellner (2008), p. 491

<sup>2</sup> Kellner (2010), p. 149

been expanded as well as maintained accordingly in the fashion of enhancing editorial work.

In 2013, the new portal *bavarikon* replaced the Bavarian Federal Library Online as cultural portal of the Bavarian free state.<sup>3,4</sup> Its tasks are to digitize all cultural heritage belonging to Bavarian institutions and to make it available for users all over the world zoomable and in excellent quality. *bavarikon* embodies new ways that such a portal can go. Content-wise, on the one hand quantitatively – *bavarikon* contains nearly 300.000 digital objects, while it was only a couple of thousands in the BLO – new dimensions had been aspired; further on a uniform design, images in high-definition, stepless zooms as well as elaborate 3D-objects invite to a far greater extent to look into it than it was possible with the previous system.

Especially for the scientific content of the BLO, like the Freising manuscripts, *bavarikon* does not provide adequate space anymore in its current form. Despite the fact that all manuscripts of the project have already been incorporated into *bavarikon* and it is expectable that in the future also individual images of a digitized manuscript will be equipped with a button containing page-precise texts like a transcription or an edition – the entirety as well as elaborate links, which the digital edition within the BLO provides will also not be realized within *bavarikon* in the future.

Due to the (in-)consistency of digital data, the question of the future repository for the edition is to be asked middle-termed, after the foreseeable end of the BLO. This case only highlights the advantage of an institutional connection of the edition to a knowledge memory, like the one of the Bavarian State Library. Not only all the associates (and all institutions involved) are aware of the significance of the edition, through the efforts of the BSB in the area of long-term archiving and data preservation, a permanent accessibility of the data is secured. Apart from the fixation of the current condition within long-term archiving within the BLO, it could also be available in a separate digital offer (in the form of a wiki) or within a still to be created platform for digital editions. Therefore, the editing of the texts in html-format, which was carried out for the BLO, could be useful, because it generally allows for a transmission into another system.

<sup>3</sup> Ceynowa (2015), p. 292

<sup>4</sup> Ceynowa (2016), p. 13

## References

Bitterauf, Theodor (1905, 1909): Die Traditionen des Hochstifts Freising, Band 1 (744-926), (Quellen und Erörterungen zur bayerischen und deutschen Geschichte NF 4, Munich 1905), t. 2 (926-1283), (Quellen und Erörterungen zur bayerischen und deutschen Geschichte NF 5, Munich 1909).

Ceynowa, Klaus; Kellner, Stephan (2015): Das bayerische Kulturportal *bavarikon* – digital, vernetzt, spartenübergreifend. In: Ellen Euler a.o. (Ed.), Handbuch Kulturportale. Online-Angebote aus Kultur und Wissenschaft (Berlin/Boston 2015) pp. 292–300.

Ceynowa, Klaus; Sepp, Florian (2016): Das Landesportal "bavarikon" in kulturpolitischer Perspektive. In: Bibliotheksmagazin 11, Issue 2 (2016) pp. 13–16.

Heinemann, Otto v. (1966): Die Augusteischen Handschriften 4. Cod. Guelf. 77.4 Aug. 2° – 34 Aug. 4°. Frankfurt/M.: Klostermann, 1966 (Nachdruck d. Ausg. 1900) pp. 145 – 146.

Kellner, Stephan; Krahe, Adelheid (2010): Vom digitalen Faksimile zur Online-Edition. Das Projekt der Digitalisierung und Neuerschließung der wertvollsten Freisinger Amtsbücher im Bayerischen Hauptstaatsarchiv. In: Archive in Bayern 6, ed. by Generaldirektion der staatlichen Archive Bayerns (Munich 2010) pp. 149-164.

Kellner, Stephan; Kempf, Klaus (2008) Kellner, Stephan; Kempf, Klaus: Die Bayerische Landesbibliothek Online. Das landeshistorische und kulturwissenschaftliche Internetportal Bayerns. – In: Griebel, Rolf Ceynowa, Klaus (Ed.), Information, Innovation, Inspiration. 450 Jahre Bayerische Staatsbibliothek (Munich 2008) pp. 491–510.

Schulz, Knut (1982), Schulz, Knut Zensualität und Stadtentwicklung im 11./12. Jahrhundert. In: Bernhard Diestelkamp (Ed.), Beiträge zum hochmittelalterlichen Städtewesen. Städteforschung A/11, (Cologne, Vienna 1982) pp. 72-93.

Wild, Joachim (2006), Wild, Joachim, Libri censualium. In: Hetzer, Gerhard, Uhl, Bodo (Ed.),

Festschrift Hermann Rumschöttel zum 65. Geburtstag  
(Archivalische Zeitschrift 88, 2, Cologne, Vienna 2006)  
pp. 1105-1122.

Will, Maresa (2004) Will, Maresa (Ed.): Der  
Bücherfürst des 17. Jahrhunderts. Herzog August der  
Jüngere. (Vernissage. 136, Nr. 4, Heidelberg 2004).

edited by Lukas Russ, Department of History,  
University of Vienna, Austria,  
[a01303036@unet.univie.ac.at](mailto:a01303036@unet.univie.ac.at)



### Authors CVs and contacts:

**Adelheid Krah** - PhD habilitated at the University of Vienna in 2002. She holds the position of Senior Lecturer for medieval history and e-learning; she researches and publishes in the field of the constitutional, social and cultural history of the European middle ages as well as women and gender history. Her online editions of the official register books of Freising are hosted on the portal of the Bavarian Federal Library Online (BLO) of the Bavarian State Library Munich. She is a member of the executive board of the International Centre for Archival Research (ICARUS) and has managed the task group “En route to a shared Identity” for research on new sources for Central Europe since 2014.

Department of History, University of Vienna, and Institute of Austrian Historical Research, University of Vienna Austria, [adelheid.krah@univie.ac.at](mailto:adelheid.krah@univie.ac.at)

**Stephan Kellner** - PhD has been head of the Bavarica department at the Bavarian State Library Munich, BSB (Germany) since 2015 and is lecturer at the Ludwig-Maximilian-University Munich. His research and fields of interest concern the internet provisions of Bavarian culture, history and literature as well as the building and the content supervision of online portals at the BSB, such as:

- [Bayerische Landesbibliothek Online](#) (online since 2002)
- [Historisches Lexikon Bayern](#) (online since May 2006)
- [Literaturportal Bayern](#) (online since July 2012)
- [bavarikon – Kultur und Wissensschätze Bayerns](#) (online since April 2013)

Numerous relevant publications have been issued: [https://www.bg.geschichte.uni-muenchen.de/personen/lehrbeauftragte/kellner\\_stephan/publ\\_kellner\\_stephan/index.html](https://www.bg.geschichte.uni-muenchen.de/personen/lehrbeauftragte/kellner_stephan/publ_kellner_stephan/index.html)

Further fields of interest are the history of the book as well as the history of Bavarian libraries and historical research on National-Socialist loots.

Bavarica Department, Bavarian State Library Munich, Germany, [Stephan.kellner@bsb-muenchen.de](mailto:Stephan.kellner@bsb-muenchen.de)

*Svetlana A. DOBRUSINA<sup>1</sup>, Natalia I. PODGORNAYA<sup>1</sup>, Galina K. MALINOVSKAYA<sup>2</sup>,  
Lidia V. LITVINOVA<sup>2</sup>*

*1 Federal Centre for Document Conservation, National Library of Russia, S-Pb, Russia  
2 Higher School of Technology and Energy, St. Petersburg State University of Industrial Technology  
and Design, S-Pb, Russia*

## **Filling in Missing Parts of Documents by the Method of Air Dynamic Forming**

### **Abstract**

The article deals with the results of experiments on filling in missing parts of documents with drawings and text made of water-soluble materials by the method of Air Dynamic Forming (ADF). The ADF technique is based on the concept that moist fibres can be dispersed in airflow followed by air spreading of the fibres onto a wire. Due to ADF technique semi-dry fibres dispersed in airflow are spread by air onto a wire. The process is a combination of conventional wet and dry forming, eliminating the need for water as a fibre carrying and spreading medium. The lost parts of various types of paper are replenished by the ADF method. The optical standard tests on the paper with drawings made of water-soluble materials (watercolours, ink, Indian ink, graphite pencil) demonstrated that the filling process applied to the paper had no negative impact on those materials.

**Key words:** paper conservation, air dynamic paper forming, water-soluble drawings, cellulose fibre spraying

## Introduction

Filling in missing parts of damaged documents with drawings and text made of water-soluble materials by water-fibre suspension can cause blurring of paints and inks. The preservation of the colourful range is particularly important, because water can distort the information itself and its perception.

A promising method of such documents conservation is the method of Air Dynamic Forming (ADF). Missing parts are filled in by cellulose fibres from the air suspension on a special laboratory equipment<sup>1,2,3,4</sup>. Unlike the traditional method of paper making, ADF does not require a large volume of water. The insertion in ADF process is made with the natural fibres of wood cellulose origin allowing introducing reinforcing components: fillers, sizing and stabilizing substances, biocides. The introduction of additives is provided either together with the deposition of fibres or in the process of fibre preparation, thus the retention of paper composition components in the structure of paper formed by ADF method is maximized. Moistening an insertion, made by ADF method, requires strictly limited amount of water ensuring preservation the original structure of the paper and the colour quality of the text and drawings.

Comparison of colour characteristics (reflection factor) of samples with different water-soluble materials (watercolours, ink, Indian ink, graphite pencil) applied to the paper shows lack of changes after filling.

The good joint between the document and insertion was achieved by using sodium salt of carboxymethyl cellulose and cationic starch as sizing substances.

## Method

A promising mechanical method of documents restoration is that of cellulose fibres spraying on the missing paper fragments. The method is based on the air dynamic paper forming technology (ADF).<sup>3,4,5</sup>

Paper web is formed with deposition of fibres from air flow on a forming wire. The air acts as the technological medium transferring fibres and paper components

inside the forming equipment. The suggested process allows applying natural wood fibrous raw material together with extra reinforcing components such as fillers, sizing agents and stabilizing agents, biocides if required.

There exists the method of "dry" specialty paper forming.<sup>6,7</sup>

It is based on the use of long-fibre raw material (cotton, synthetic fibres) and binders in amounts up to 30% of fibre weight. Wide range of reinforcing substances changes the restored paper composition and increases its cost. The proposed air dynamic forming technology and equipment are designed for making paper and paperboard using wood cellulose pulp.

The conventional papermaking technology<sup>8</sup> uses water as both a technological medium for transporting fibrous material inside paper machine equipment and an active component involved in the physicochemical interaction of the fibres.

In the ADF method the binding capacity is ensured due to keeping unchanged the original fibre length as well as fibre moisture content at the level of 0.4 kg/kg of fibre in the fibrous layer on the wire. It allows utilizing hydrogen bonding potential of the pulp. Additional paper web moistening during pressing increases the water content up to 2.0 kg/kg of fibre. Press drying is the procedure ensuring main bonding. Thus, the ADF method allows reducing energy consumption for fibrous layer dehumidification and paper drying as compared with the conventional wet paper making method. The ADF method allows forming a fibrous layer with a mass of a square meter in the range of 25-200 g/m<sup>2</sup>. Recovery of missing fragments of paper documents was carried out with a laboratory device of batch operation intended for air dynamic forming of paper samples.

Fig.1 shows a laboratory installation for replenishing missing fragments of paper documents with air dynamic forming. The installation operation is described below. The paper documents to be restored are placed on a forming wire 4. The weight of the sprayed fibrous layer depends on the missing area and

<sup>1</sup> Droboşyuk (2011), p. 56

<sup>2</sup> Terentiev (2000), pp. 421-424

<sup>3</sup> Kononov et al (2004), pp. 97-102

<sup>4</sup> Kononov et al (2002), pp. 37-48

<sup>5</sup> Schinner et. al (2016), pp. 36-42

<sup>6</sup> Grandmaison/Gupta (1986), pp. 110-113

<sup>7</sup> Bentley/Pye (1979), pp. 77-83

<sup>8</sup> Norman (1999), pp. 195-199

the basis weight of the paper document to be restored. These parameters are determined before the conservation. The broken ridge of the sheet is treated with a binder solution with a brush to harden the connecting seam. Solutions of sodium salt of carboxymethylcellulose or cationic starch were use as sizing substances with weight concentration 1 %. Different pulp types of natural origin (softwood, hardwood, cotton, waste paper and others) can be used for filling the missing parts of document.

The cellulose material is moistened up to 45% and fed through the inlet pulp 2 into the internal container of the disperser 1. In the disperser the cellulose pulp is

fibrillated to individual fibres. Fibres are moved into a forming shaft by air stream blown by the fan 6 and settle on the open areas of the wire 4, recovering the structure of missing fragments of the document sheet.

The paper document being restored is removed from the forming wire, placed between two moist press felts, moistened up to 60% at a roller press at the specific pressure of 7 kg /cm<sup>2</sup>. Paper document placed between two dry press felts for pressing at a roller press at the specific pressure of 140 kg /cm<sup>2</sup>. Then, the paper document is dried at the temperature of 100°C.

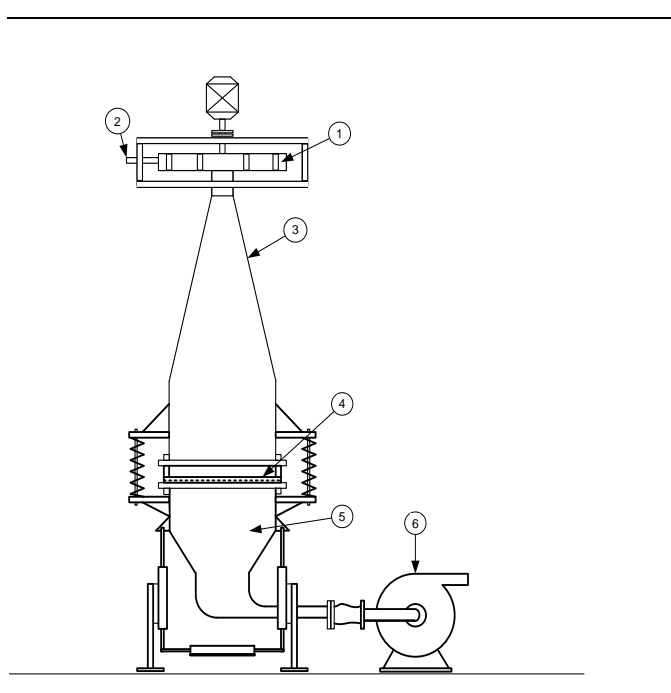

**Fig.1** Laboratory equipment for filling in missing parts of documents by the method of air dynamic forming: 1 – disperser; 2 - fed pulp; 3 - forming shaft; 4 - forming wire; 5 - air duct; 6 - exhaust air fan

**Table 1**  
**Comparative parameters of two paper restoring installations.**

	Method of paper restoration	Hand-sheet former	ADF installation
1	Technological medium	Water	Air
2	Water consumption, kg water / kg fiber	99,0	2,0
3	Conservation of paper containing water-soluble drawings and text	Poor	Good
4	Retention of components in a paper sheet	Partial	Full
5	Maximum conservable paper document area, m <sup>2</sup>	up to 1,0	0,2
6	Time need for one sheet of paper document conservation, min	10-15	10 -15

Paper web is formed through depositing pulp fibres from a semi-dry air flow on a wire. At this humidity water is retained in the volume of the walls of the fibres saving their plasticity. The limited amount of water used in the ADF method guarantees the safety of damaged paper documents and texts made with water-soluble ink and paints.

Two methods for replenishing of the missing fragments of paper documents (the method of paper stock filling-up with a hand-sheet former (1) and the method of fibres spraying with the laboratory air dynamic forming installation (2)) are compared (Table 1).

Restoration of missing fragments of damaged documents containing drawings and text applied with water-soluble paints and inks with the use of the first method (1) can disturb paper structure and leads to blurring of the paints and inks. It is possible to fix water-soluble paints and inks however this procedure is time consuming and requires appropriate reagents.<sup>9</sup>

These problems are easily solved by using the ADF method characterized by its strictly limited water volume. To maximize the retention of paper stock components (fillers, reinforcing and sizing additives, biocides) in the structure of the fibrous layer formed with the ADF method the additives are introduced either together with spraying fibres or by means of additional wetting of the fibrous layer up to its water or binder solution content 2,0 kg/kg fibre in accordance with the ADF-technology.

The following of paper pulp to be used in this work was involved: the cellulose material - softwood sulfate cellulose, sizing - sodium salt of carboxymethylcellulose and filling - calcium carbonate.

The sizing substance was added at the fibre preparation stage, 10 % to air-dry cellulose, filling 5 % to air-dry cellulose – through the channel feed in the disperser at the stage of papermaking.

The maximum size of the restorable paper document area is determined by the size of the installation's forming wire used for filling in the missing fragments of the paper sheet.

## Materials

The following types of drawing materials were used in investigations: different watercolours, aniline inks, Indian inks, and graphite pencil.

The following materials were applied on three types of paper: newsprint paper 80 g/m<sup>2</sup>, 100 % cotton cellulose paper of experimental production 100 g/m<sup>2</sup>, 100 % cotton cellulose paper of experimental production 200 g/m<sup>2</sup>.

All samples with applied drawing materials were broken in various directions and every part then was filled to original size by the method of air dynamic forming.

## Experimental

Paper samples produced by ADF method were tested before and after 12 days of dry accelerated ageing at 105 C° for their breaking strength after multiple folds at a tension, tensile strength and brightness. The results of mechanical tests showed absence of negative change of physical and mechanical properties of paper.

The reflection factor of all samples with applied dyes before and after filling in missing parts was measured using a single-ray spectrophotometer "Spekol-11" with a blue filter and the wave length of 457 nm according to the State Standard 7690.

The results of optical tests were statistically analyzed, calculating standard deviation and t-distribution.

## Results

Results obtained through optical testing led to the conclusion that the process of filling missing parts by ADF method itself had no negative influence on reflection factor of colour layer of the most drawing materials (Table 2).

Changes in the colour of information recording materials applied on paper after restoration of the missing fragments of the paper document with the ADF method.

<sup>9</sup> Nyuksha/Blank (1976), pp. 25-33

**Table 2**

Paper as information carrier	Information recording material	Reflection index	
		Before recovering	After recovering
Newsprint	Dye free	0,58±0,02	0,55±0,02
	Copying pencil	0,39±0,02	0,38±0,02
	Green ink	0,14±0,01	0,16±0,01
	Blue ink	0,22±0,01	0,32±0,01
	Violet ink	0,25±0,01	0,28±0,01
	Indian ink	0,04±0,012	0,04±0,00
	Red ink	0,16±0,01	0,16±0,01
Cotton, Basis weight 100 g/m <sup>2</sup>	Dye-free	0,83±0,02	0,82±0,03
	Indian ink	0,35±0,01	0,44±0,02
	Red ink	0,18±0,01	0,20±0,01
	Yellow watercolour	0,17±0,01	0,25±0,01
	Green watercolour	0,21±0,01	0,24±0,01
	Red watercolour	0,31±0,02	0,37±0,02
	Blue watercolour	0,31±0,01	0,37±0,02
Cotton, Basis weight 200 g/m <sup>2</sup>	Dye-free	0,87±0,03	0,85±0,04
	Indian ink	0,03±0,00	0,05±0,00
	Red ink	0,20±0,01	0,22±0,01
	Yellow watercolour	0,16±0,01	0,20±0,01
	Green watercolour	0,26±0,01	0,26±0,01
	Red watercolour	0,26±0,01	0,27±0,01
	Blue watercolour	0,27±0,01	0,33±0,01

There are no changes in the case of both types Indian ink applied to the newsprint paper, green watercolour applied to 100 % cotton cellulose paper (200 g/m<sup>2</sup>). The value of reflection factor increased in the case of all kinds of aniline ink applied to the newsprint paper, red Indian ink, green watercolour applied to 100 % cotton cellulose paper (100 g/m<sup>2</sup>), black and red Indian ink, yellow and red watercolour applied to 100 % cotton cellulose paper (grammage 200 g/m<sup>2</sup>). The value of optical characteristic decrease in case of graphite pencil applied to the newsprint paper. Comparison of the reflection factor of drawing materials applied to different kinds of paper before and after filling the missing parts of samples by ADF showed almost no changes, i.e. the changes were within the instrument error that was 0.5 %.

The changes of reflection factor in few cases slightly exceed the instrument error in the case of black Indian ink, yellow and red watercolours applied to the 100 % cotton cellulose paper (100 g/m<sup>2</sup>), blue watercolours applied to the 100 % cotton cellulose paper (200 g/m<sup>2</sup>).

The ADF method makes it possible to obtain a wide range of strength properties of the document paper due to the use of reinforcing additives for preliminary

treatment of pulp and broken edges of the document and wetting the restored sheet.<sup>10</sup> When restoring the lost fragments of the paper documents, fibres were treated with the solution of sodium-carboxymethyl cellulose. Solution of cationic starch was used for treating the broken edges before spraying the fibres and for wetting the sheet on completion of the restoration procedure.

## Conclusion

The investigations demonstrate that it is possible to fill in the missing fragments of paper documents using the Air Dynamic Forming method of fibres spraying. The method and the ADF installation can be used for conservation paper grades of different composition identical to the papers of ancient manuscripts and documents. The basis weight of the specialty papers may vary in the range from 25 to 200 g/m<sup>2</sup>.

The results of investigations showed the possibility of practical conservation of documents with drawings and texts made by water-soluble drawing materials by the method of air dynamic forming.

<sup>10</sup> Podgornaya et al (1996), pp. 87-95

The erosion of water-soluble inks and paints, as well as the loss of intensity of the colour scale were not observed.

The offered ADF method can be used also for the restoration of book covers made of natural or artificial leather.

Statistical analysis of data confirmed that changes of values reflection factor occur within the standard deviation of the arithmetic mean and the acceptable error in device readings. The filling missing parts by ADF method itself did not cause considerable changes of reflection factor of drawing materials applied to the paper.

### References

- Bentley S., Pye I.: Bonding of Air –Formed Webs. In: Pulp & Paper Canada J. V. 80, 12 (1979), pp. 77-83
- Drobosyuk (2011) Drobosyuk Viktor: Aerodynamic paper technology, St. Petersburg, 2011
- Grandmaison E., Gupta A.: Fibrillation of pulp in dry state. In: TAPPI J. V.69, 8 (1986), pp. 110-113
- Kononov A., Drobosyuk V., Paulapuro H.: Application of the Air Dynamic Forming method for coarse mechanical pulp. In: 58<sup>th</sup> Appita Annual Conference and Exhibition, incorporating the Pan Pacific Conference, Canberra, Australia, I (2004), pp. 97-102
- Kononov A., Paulapuro H., Drobosyuk V., Malinovskaya G., Terentiev O.: Air Dynamic Forming as an alternative to commercial papermaking concepts. In: XXXIII ATICELCA ANNUAL MEETING, Modena, Italy (2002), pp. 37-48
- Norman B.: Web forming. Papermaking. Part 1. Helsinki 1999
- Nyuksha Yu., Blank M.: Production line for the restoration of books. M. 1976.
- Podgornaya N., Dobrusina S., Chernina E., Drobosyuk V., Litvinova L.: Replenishment of the missing parts of sheets of documents by aerodynamic molding (ADF). In: Theory and practice of preserving cultural monuments. St. Petersburg 18 (1996), pp. 87-95
- Schrinner T., Gilat T., Grossmann H., Malinovskaya G.: Dry and semi-dry paper and cardboard production. In: Professional papermaking (2016), pp. 36-42
- Terentiev O.: New Ecologically Frenkli Technology for Aerodynamic Forming of Paper without water at speeds approachins 2000 m/min. In: EcoPaperTech 1 Conference. Finland. (2000), pp. 421-424

### Authors CVs and contacts:

**Svetlana A. Dobrusina** - graduated in non-organic substances technology from the Moscow D. I. Mendeleev Chemical Engineering Institute (Diplom-Chemist), holds a Ph. D at the Forestry Academy (St.-Petersburg) and a Ph. D. habil. of the Technical University (St.-Petersburg ). She is currently the director of the Federal Centre for Document Conservation at the National Library of Russia. Author and co-author of more that 300 publications, 3 monographs, few Patents of the Russian Federation.

Federal Centre for Document Conservation, National Library of Russia, 18, Sadovaya st., St.-Petersburg, 191069 Russia, [svetdobru@gmail.com](mailto:svetdobru@gmail.com)

**Natalya I. Podgornaya** - graduated in technology of conservation from the Technological Institute of Refrigerating Industry (St.-Petersburg), graduated course “Cultural Heritage in Danger” in the Central European University. Main Specialist of the Federal Centre for Document Conservation, National Library of Russia. Author and coauthor of more that 60 publications, co-author of 2 Patents of the Russian Federation.

Federal Centre for Document Conservation, National Library of Russia, 18, Sadovaya st., St.-Petersburg, 191069 Russia, [conservation@nlr.ru](mailto:conservation@nlr.ru)

**Galina K. Malinovskaya** - chief researcher at the St. Petersburg State University of Industrial Technologies and Design, graduated from the State Technological University of Plant Polymers as engineer, PhD in Chemistry, international projects participant “Air Dynamic Forming of Paper” (1985 and 2016), and “Air Dynamic Forming Project” (2000 – 2009). Author and co-author of more than 50 publications, 6 Patents of the Russian Federation.

St. Petersburg State University of Industrial Technology and Design, Russia, Saint-Petersburg, 191186, 18, B. Morskaya st., [m-gk@mail.ru](mailto:m-gk@mail.ru)

**Lidiya V. Litvinova** - senior researcher at the St. Petersburg State University of Industrial Technologies and Design, graduated from the Technological Institute (St. Petersburg), PhD in Chemistry of the St. Petersburg State University of Plant Polymers. In 1985-86 and 2017 was the main specialist of the project “Restoration of documents by the method of air dynamic forming”, international projects participant “Air Dynamic Forming of Paper” (1985 and 2016), and “Air Dynamic Forming Project” (2000 – 2009). Author and co-author of more that 80 publications, 3 Patents of the Russian Federation.

St. Petersburg State University of Industrial Technology and Design, Russia, Saint-Petersburg, 191186, 18, B. Morskaya st., [lidiya.litvinova@mail.ru](mailto:lidiya.litvinova@mail.ru)



### 3. UPCOMING EVENTS

#### Our events

Throughout the whole year ERC for Book and Paper Conservation-Restoration organises conferences and courses. At these events conservators, information professionals (archivists and librarians) and students from member countries get the chance to discuss matters relevant to the field of book and paper conservation. These opportunities complement their professional fields or areas of study with new qualities, provide the opportunity to upgrade their knowledge or take their first steps in their career, and increase their international experience, by establishing contacts with colleagues from across Europe.

More information about previous events can be found on our website

<http://www.restauratorenohnegrenzen.eu/erc/Courses/>

#### Call for Papers and Posters

To celebrate the 10th anniversary of the European Research Centre for Book and Paper Conservation-Restoration

#### Book Conservation: One Philosophy – Many Interpretations

5<sup>th</sup> – 6<sup>th</sup> November 2020

The conference aims to celebrate the 10th anniversary of the European Research Centre for Book and Paper Conservation-Restoration which was founded in March 2010. The aim of the centre is to bring together experts from all fields, whether they are professionals involved in actual conservation and conservation research, persons overseeing collections where conservation of written heritage is at issue, philosophers within and without the field of conservation of cultural heritage, or art historians.

#### Call for Papers

We call for original papers which

- describe the best conservation treatment, be it because of the aesthetic outcome or the particular value of the information that the treatment helps to preserve.
- bring up issues on conservation theory and philosophy which underline or contribute to the change of conservation philosophy due to changes in our world and the access to new methods in conservation we are obtaining as a result.
- deal with the interrelation between our societies and the new perception of conservation of cultural heritage.

#### Deadline for abstracts for presentations: May 1, 2020 (500 words, English).

Please send them to [patricia.engel@donau-uni.ac.at](mailto:patricia.engel@donau-uni.ac.at)

Abstracts should be about 500 words and submitted in English. You should also include a short CV. They will be peer reviewed by the academic board for the conference. Please indicate in your application if you opt for personal presentation in Krems or for a Skype presentation, in case your contribution will be selected. The selected presentations will be published as printed matter later.

#### Call for posters "Our best practice in Book Conservation: Best Results"

We invite all the participating countries to submit at least one best practice example presented on a poster. All posters will be put on display.

#### Deadline for posters: 1st Sept. 2020.

Please feel free to send it as a printout on paper (A1 or preferably A0 format) to Patricia Engel, European Research Centre for Book and Paper Conservation-Restoration, Zentrum für Kulturgüterschutz, Department Bauen und Umwelt, University for Continuing Education Krems, Dr. Karl Dorrekstr. 30, 3500 Krems, Austria.

When preparing the paper and posters, please make sure all the relevant general rules of ethics and scientific publication are duly observed. Guidelines for authors (pdf) are available on the website <http://www.restauratorenohnegrenzen.eu/erc/Publications/>

You may also apply to be included on the **Academic board** for the conference until **March 22, 2020**. Please send your applications to [patricia.engel@donau-uni.ac.at](mailto:patricia.engel@donau-uni.ac.at).

## Other's events

### 2020

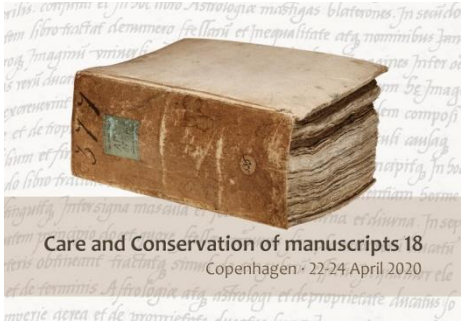
Time / Place	Event	Organizer	Links
<p>31<sup>st</sup> – 2<sup>nd</sup></p> <p><i>March / April</i></p> <p>Martin, Slovakia</p>	<p><b>2<sup>nd</sup> Annual Conference Craft and Book 2020</b></p> 	Slovak National Library	<a href="#">Information – click here</a>
<p>22<sup>nd</sup> – 24<sup>th</sup></p> <p><i>April</i></p> <p>Copenhagen, Denmark</p>	<p><b>Care and Conservation of Manuscripts 18</b></p> 	Arnamagnæan Institute, University of Copenhagen	<a href="#">Information – click here</a>
<p>7<sup>th</sup> – 8<sup>th</sup></p> <p><i>May</i></p> <p>Reykjavík, Iceland</p>	<p><b>PAPER STORIES: Paper and Book History in Post-Medieval Europe</b></p>	The Árni Magnússon Institute for Icelandic Studies, National and University Library of Iceland and the University of Iceland	<a href="#">Information – click here</a>

<b>June / July</b>	29 <sup>th</sup> – 3 <sup>rd</sup> Valletta, Malta	<b>DSL2020 MALTA, 16th International Conference on diffusion in solids and liquids</b>  	Esslingen University of Applied Sciences, GERMANY/The University of Newcastle, AUSTRALIA/ University of Porto, PORTUGAL/K.N. Toosi University of Technology, IRAN	<a href="#">Information – click here</a>
<b>October</b>	14 <sup>th</sup> – 18 <sup>th</sup> Beijing, China	<b>ICOM-CC 19th Triennial Conference Theme: Transcending Boundaries: Integrated Approaches to Conservation</b>	Arnamagnæan Institute, University of Copenhagen	<a href="#">Information – click here</a>

#### 4. CALL FOR PAPERS FOR THE APRIL ISSUE 2020

Contributions are welcome on current research articles relevant to book and paper conservation – restoration.

#### Articles should be sent to the editors:

Zoë Reid [zoereid2399@gmail.com](mailto:zoereid2399@gmail.com)

Maria Dmitrieva [bioest.maria@gmail.com](mailto:bioest.maria@gmail.com)

Articles should be submitted in English and will be peer-reviewed.

#### Full guidelines for authors can be found here:

[http://www.restauratorenohnegrenzen.eu/erc/Publications/documents/guidelines\\_for\\_authors.pdf](http://www.restauratorenohnegrenzen.eu/erc/Publications/documents/guidelines_for_authors.pdf)

We also welcome genuine contributions on aspects of the history of conservation of manuscripts, books, graphic art.

We believe we can learn from the past:

- What conservation practices were good methods and are not employed any more, but should be engaged/involved again;
- What methods have been shown to be not a good practice, but are still applied and should be stopped for good reasons.
- How can we deal with impact of old conservation methods without knowing the old conservation material in detail?

#### Deadline for articles to be included in the April issue 7 February 2020

## ***IMPRESSUM***

### **European Research Centre for Book and Paper Conservation-Restoration**

Address: Rosenhügelweg 24, 3550 Langenlois, Austria

Tel.: +43(0) 650 58 71 877

E-Mail: [patricia.engel@donau-uni.ac.at](mailto:patricia.engel@donau-uni.ac.at)

Web page: [www.donau-uni.ac.at/paper-conservation](http://www.donau-uni.ac.at/paper-conservation)

ISSN: 2225-7853

*Sponsors*

**format**werk  
value added paper products

**LENZING**  
PAPIER



ADEVA

**GEPA** pictures  
www.GEPA-pictures.com

**ZEISS**



storaenso

<http://www.restauratorenegrenzen.eu/erc/>

**ISSN: 2663-0125**